

НІН

101

J&M HYDRAULIC IMPACT HAMMERS - FULL LINE

IMPACT HAMMER SPECIFICATIONS

	Model:	<u>70</u>	<u>82</u>	<u>115</u>	<u>160</u>	<u>220</u>	<u>275</u>	<u>345</u>
Ram weight	lbs	7,000	8,200	11,500	16,000	22,000	27,500	34,500
Maximum stroke	ft-in	3'-0"	4'-0"	4'-0"	4'-0"	4'-0"	4'-0"	4'-0"
Minimum stroke	ft-in	1'-0"	1'-0"	1'-6"	1'-6"	1'-0"	1'-0"	1'-0"
Hammer weight	lbs	13,400	13,840	17,000	28,600	35,000	47,650	54,650
Hoses weight	lbs	850	850	850	1,340	1,340	1,340	1,500
Hydraulic hose length	ft-in	100	100	100	100	100	100	150
Width	D in	20	26	26	32	32	36	36
Depth	W in	36	36	36	46	48	54	60
Length (hammer only)	H ft-in	15'-5"	19'-9"	19'-9"	20'-3"	20'-3"	22'-8"	22'-8"

POWER UNIT SPECIFICATIONS

	Model:	<u>108H</u>	<u>108H</u>	<u>175</u>	<u>230</u>	<u>335</u>	<u>335</u>	<u>570</u>
Engine		Diesel	Diesel	Diesel	Diesel	Diesel	Diesel	Diesel
Power	hp	108	108	200	230	335	335	535
Hydraulic Fluid Capacity	gal	60	275	275	275	275	275	385
Drive pressure	psi	2,500	2,500	2,500	5,000	5,500	5,500	4,800
Drive flow	gpm	48	48	100	70	87	87	155
Stroke control pressure	psi	1,000	1,000	1,000	1,000	1,000	1,000	1,000
Stroke control flow	gpm	10	10	10	10	5.2	5.2	6.5
Fuel Capacity	gal	75	75	122	122	122	122	150
Weight with oil & fuel	lbs	3,400	3,400	9,400	8,900	10,500	10,500	15,400
Length	ll inches	96	96	126	126	126	126	154
Width	ww inches	45	45	60	60	60	60	60
Height	hh inches	52	52	76	76	79	79	96

J&M 82HIH

Actuator

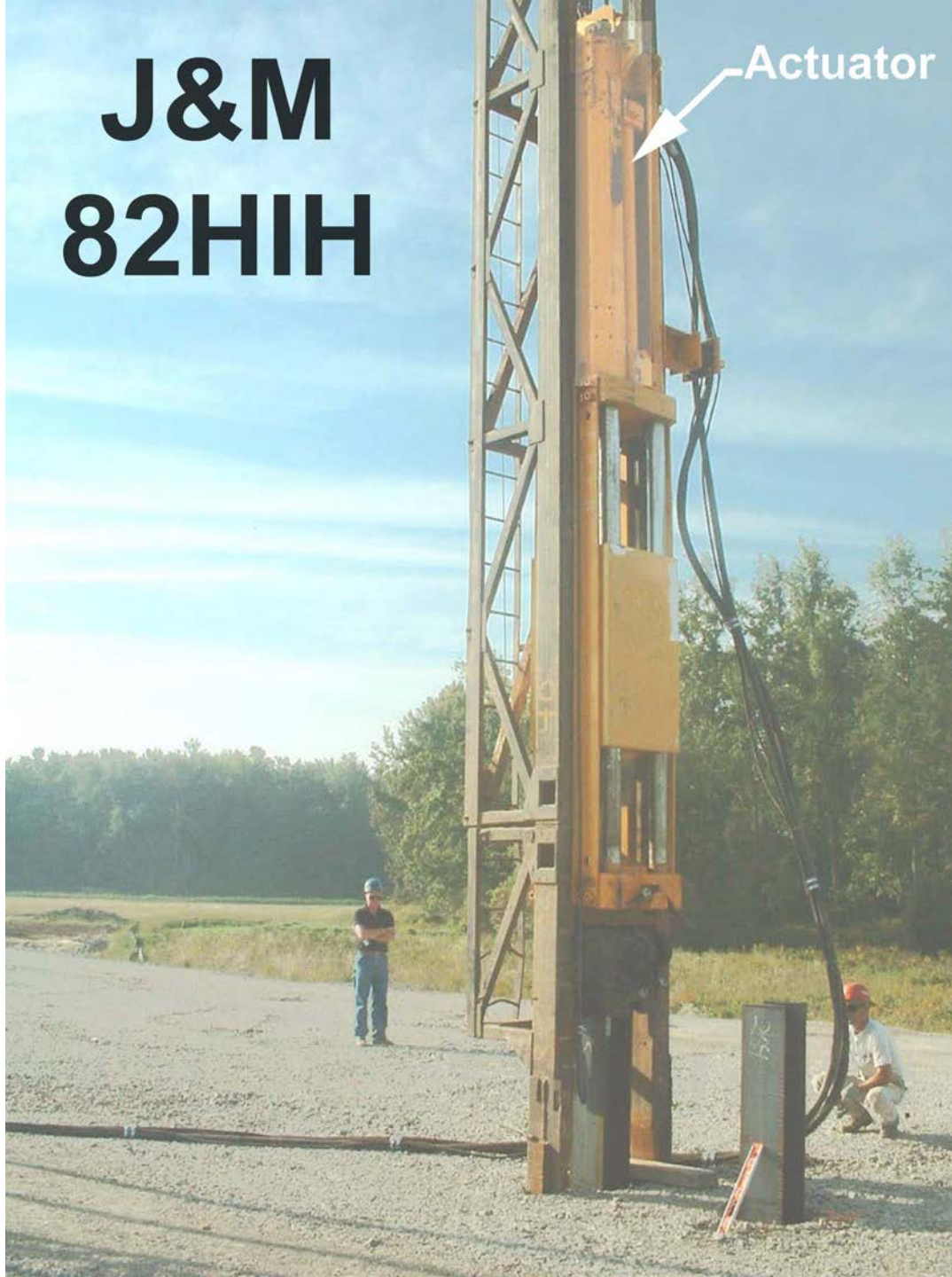

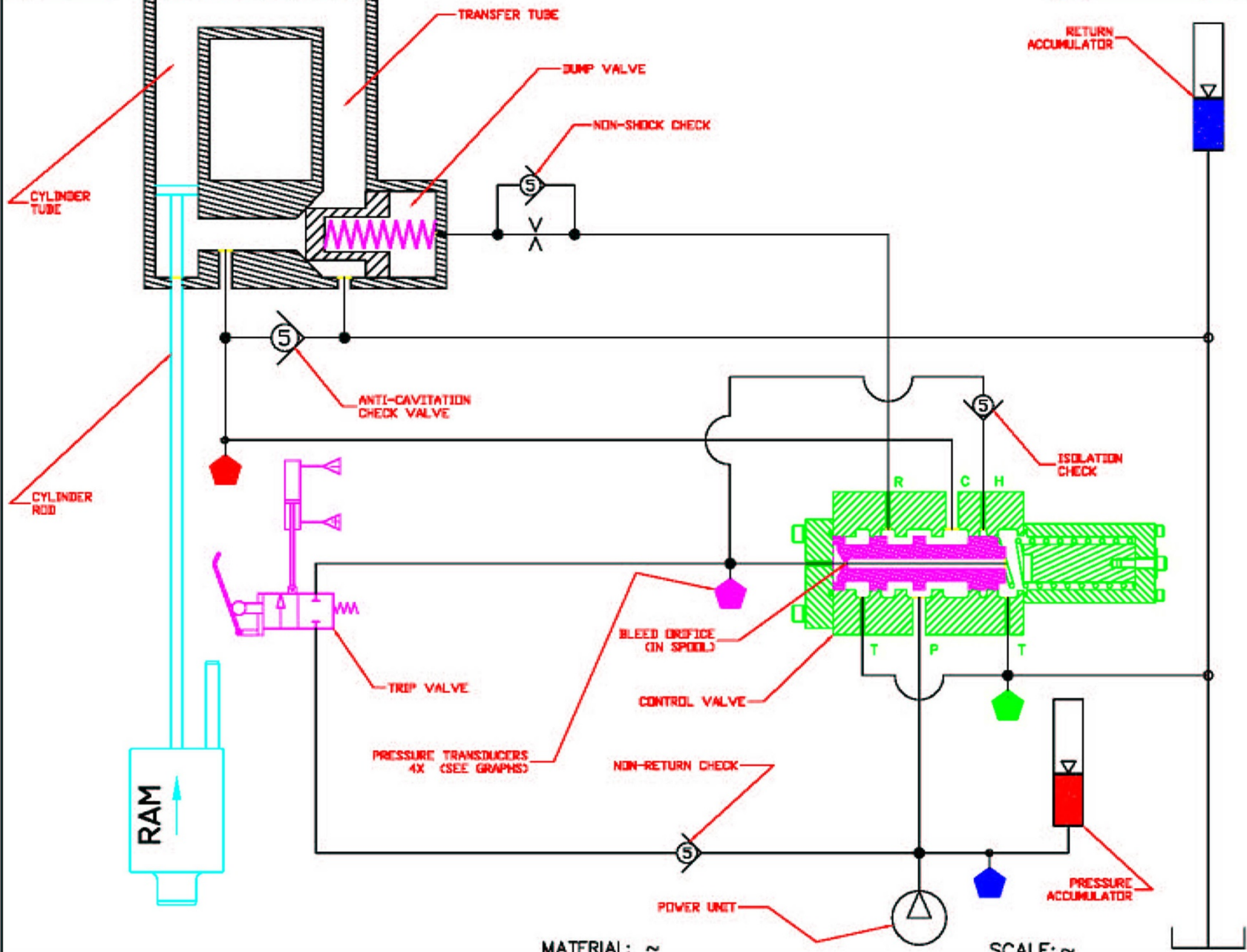

MATERIAL: ~

SCALE: ~



HIH COMPONENT IDENTIFICATION

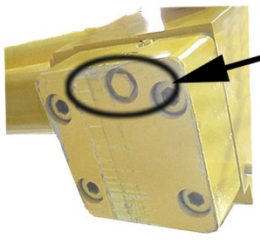

NON-SHOCK CHECK

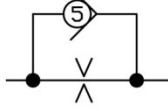

CONTROL VALVE

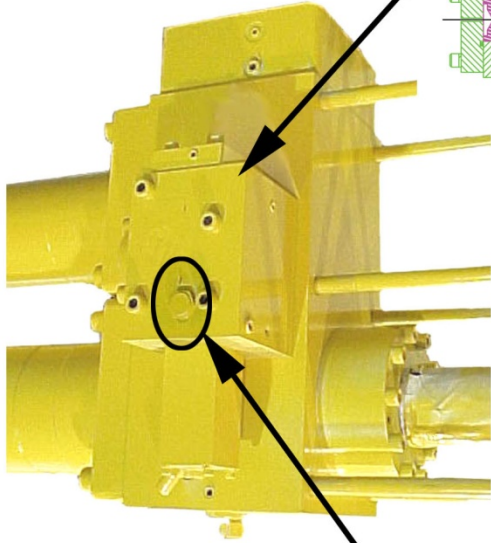
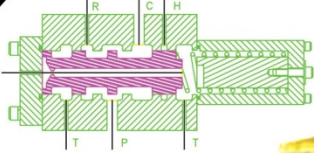

ISOLATION CHECK

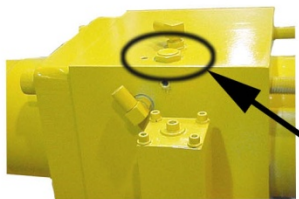

NON-RETURN CHECK



DUMP VALVE COVER

ANTI-CAVITATION CHECK

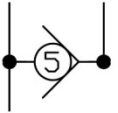

TRANSFER TUBE

CYLINDER TUBE

CYLINDER ROD

CONTROL VALVE

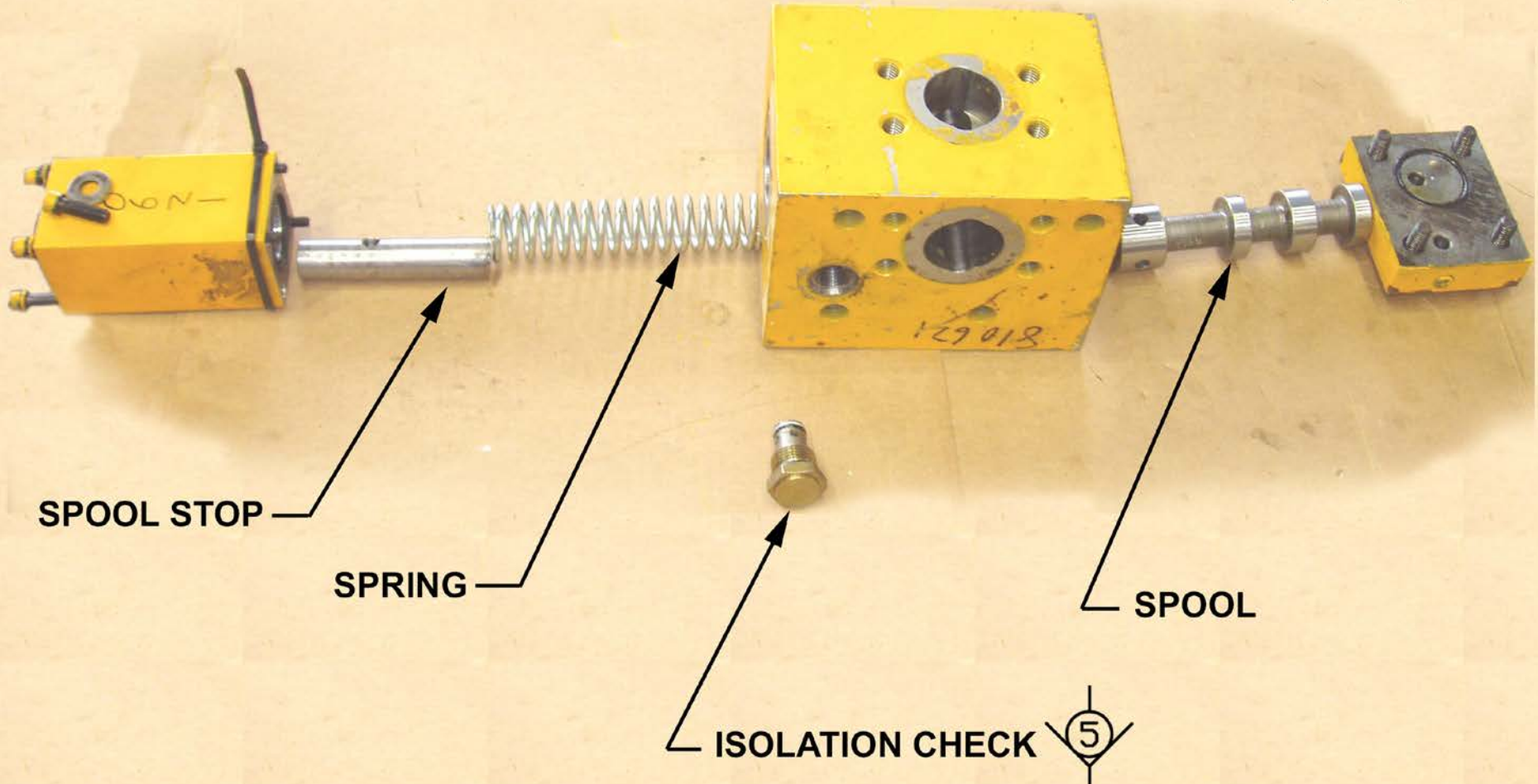
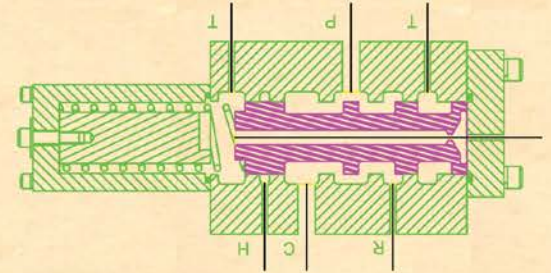

DUMP VALVE

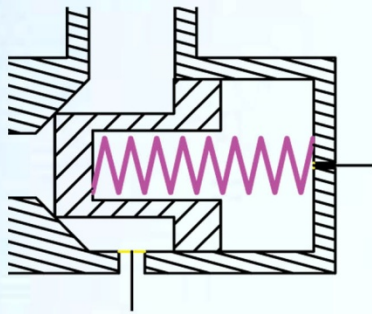

SPRING

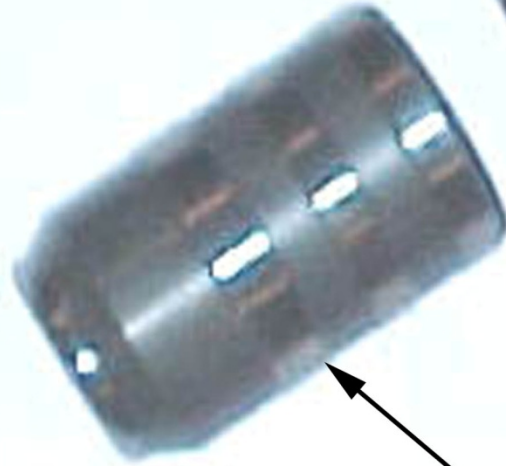

POPPET



VALVE BODY



Anti-Cavitation Check Valve

BODY WITH SEAT

COVER



POPPET

SPRING

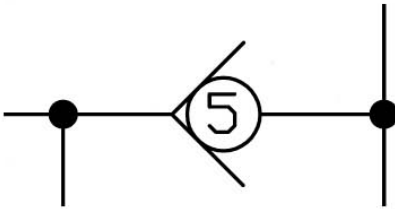

ACCUMULATOR



SAE
4-BOLT

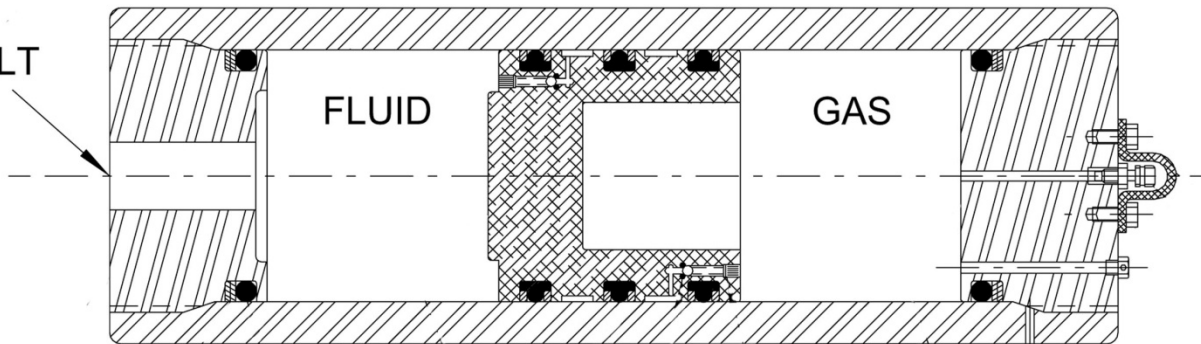

TRIP VALVE

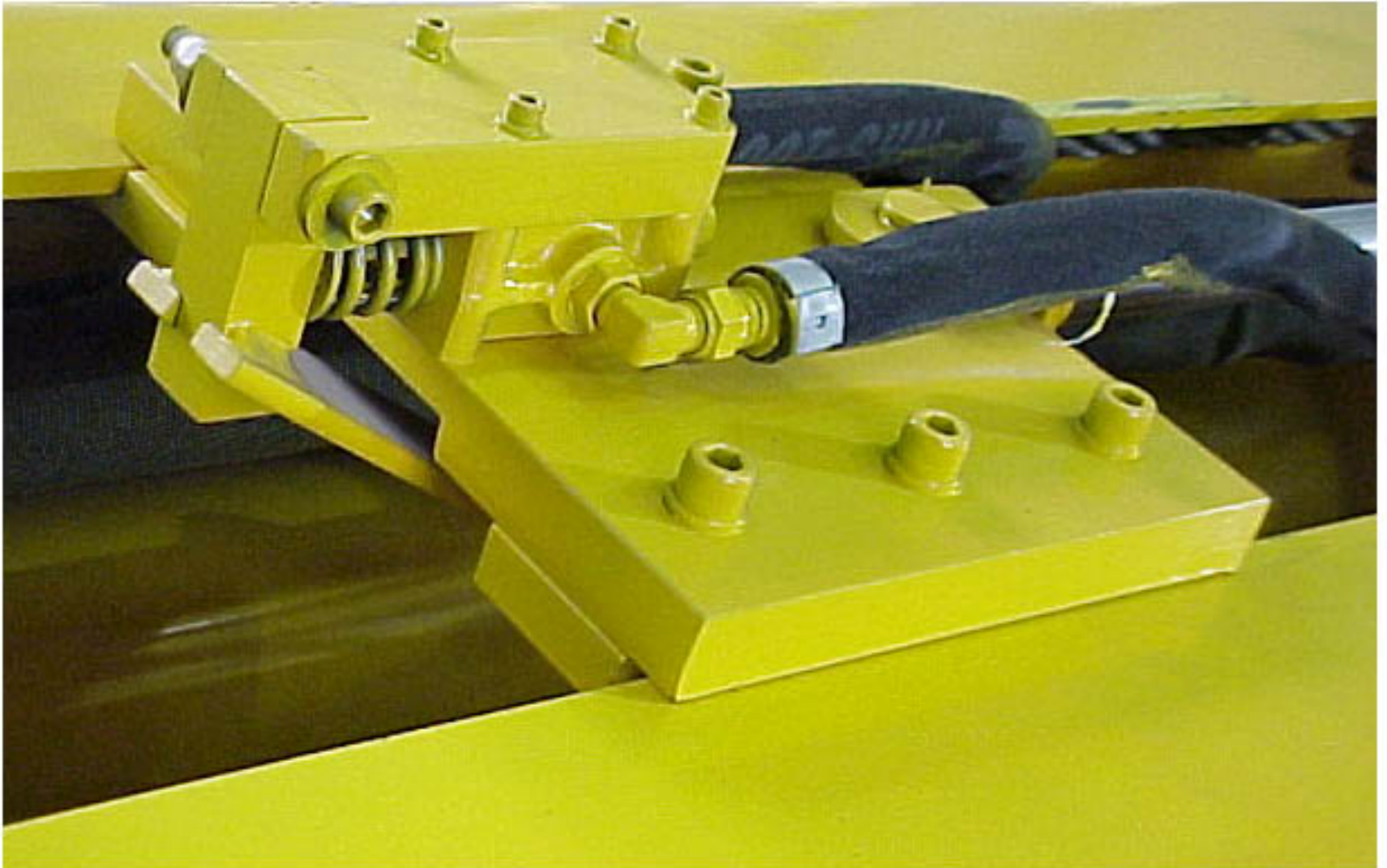
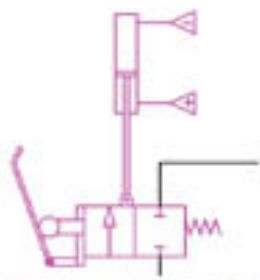

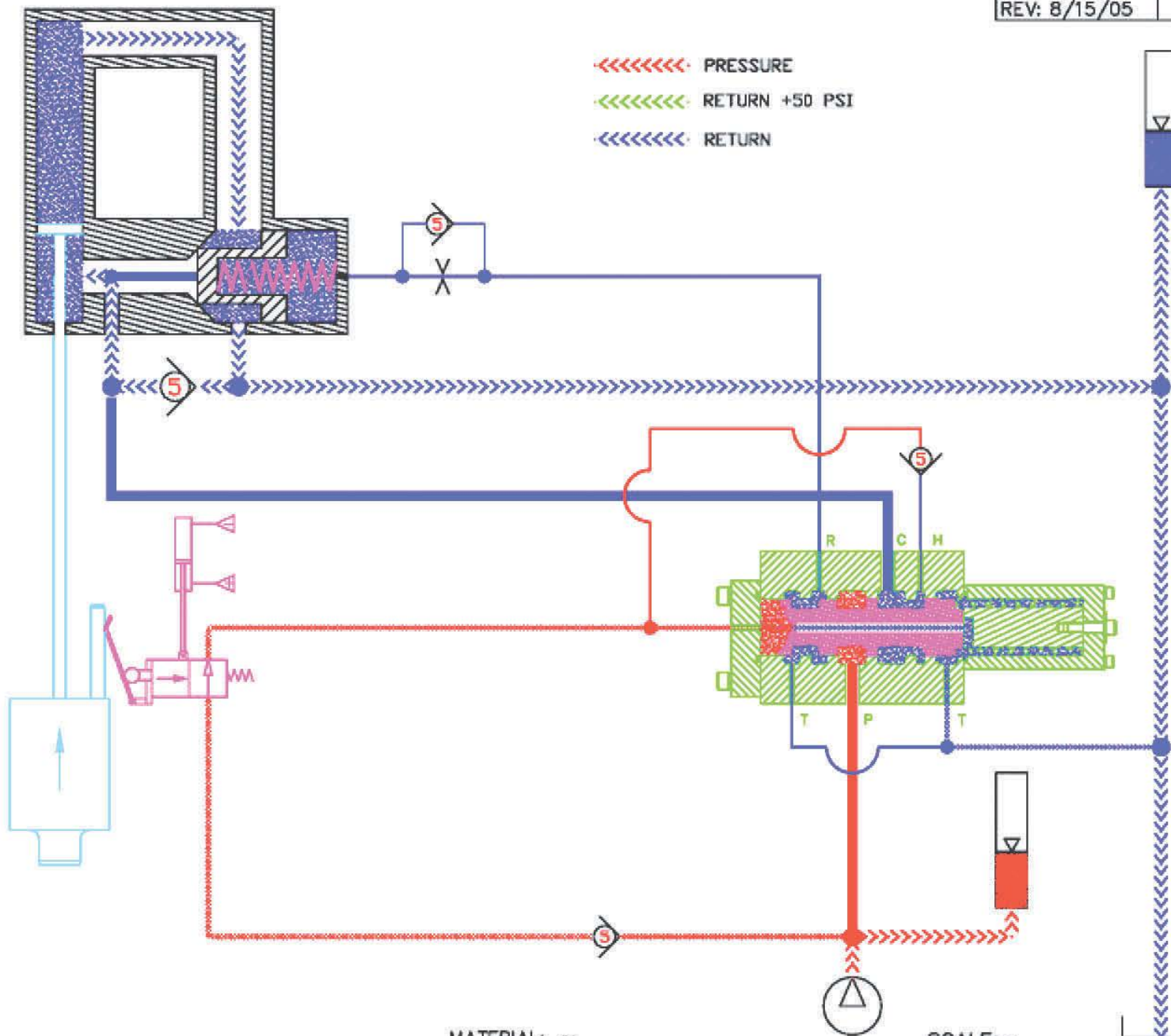

MATERIAL: ~

SCALE: ~

DWN. BY: KSE
DATE: 5/9/00

HIH HAMMERS

DESCRIPTION
TRIP + COAST

VIEW
2

FOUNDATION EQUIPMENT LLC
PITTSBURGH, PENNSYLVANIA

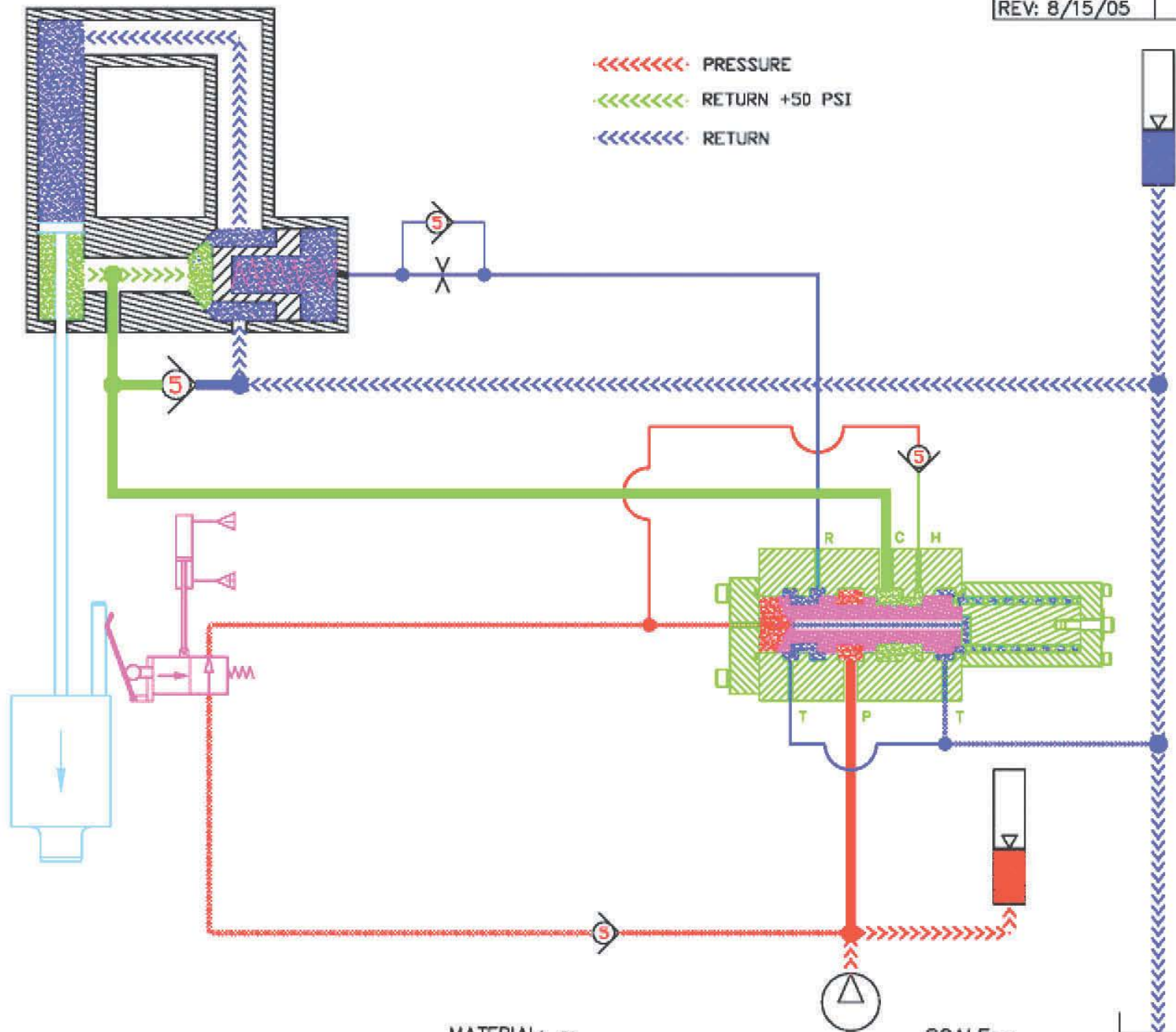

MATERIAL: ~

SCALE: ~



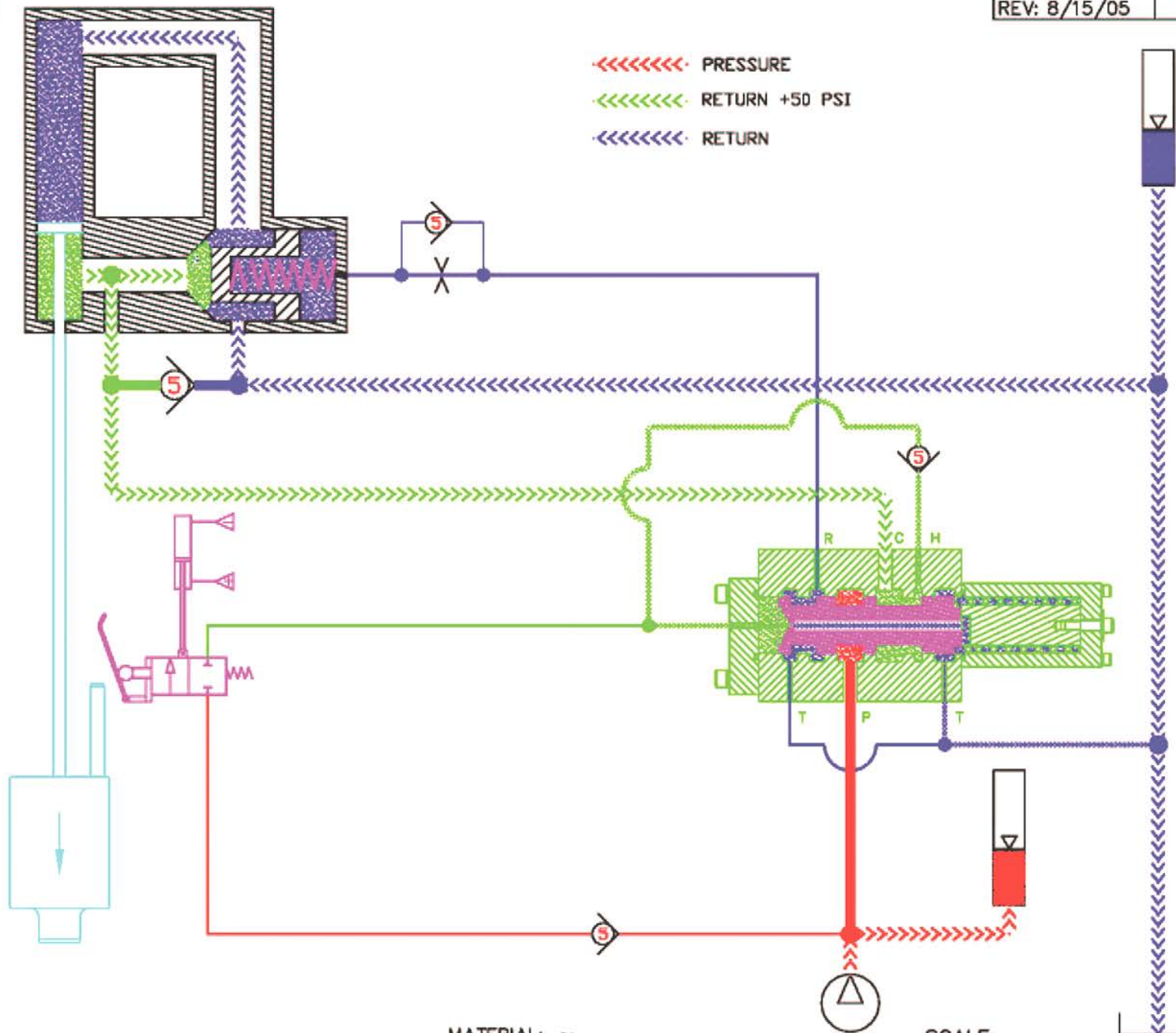

MATERIAL: ~

SCALE: ~



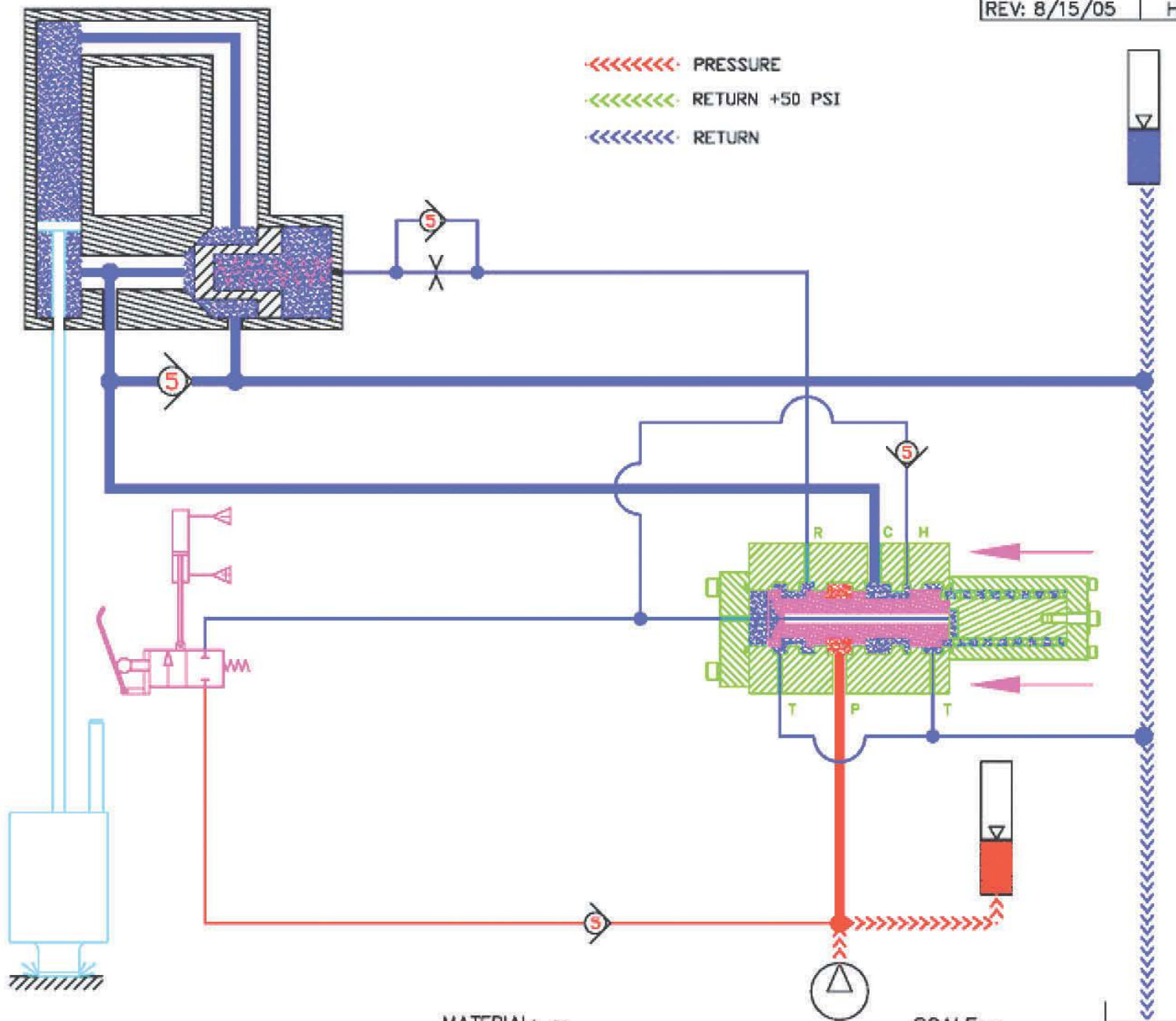

MATERIAL: ~

SCALE: ~

ORIGINAL INSTRUMENTATION RUN – 115HIH

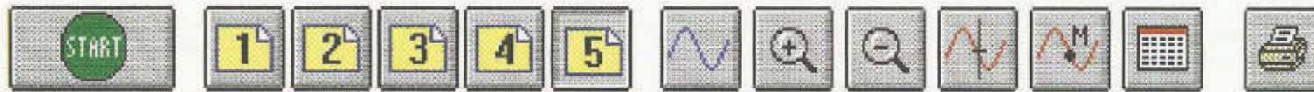

8/5 10:15:5 - 2300 RPM

Frame:1

Summary of Data

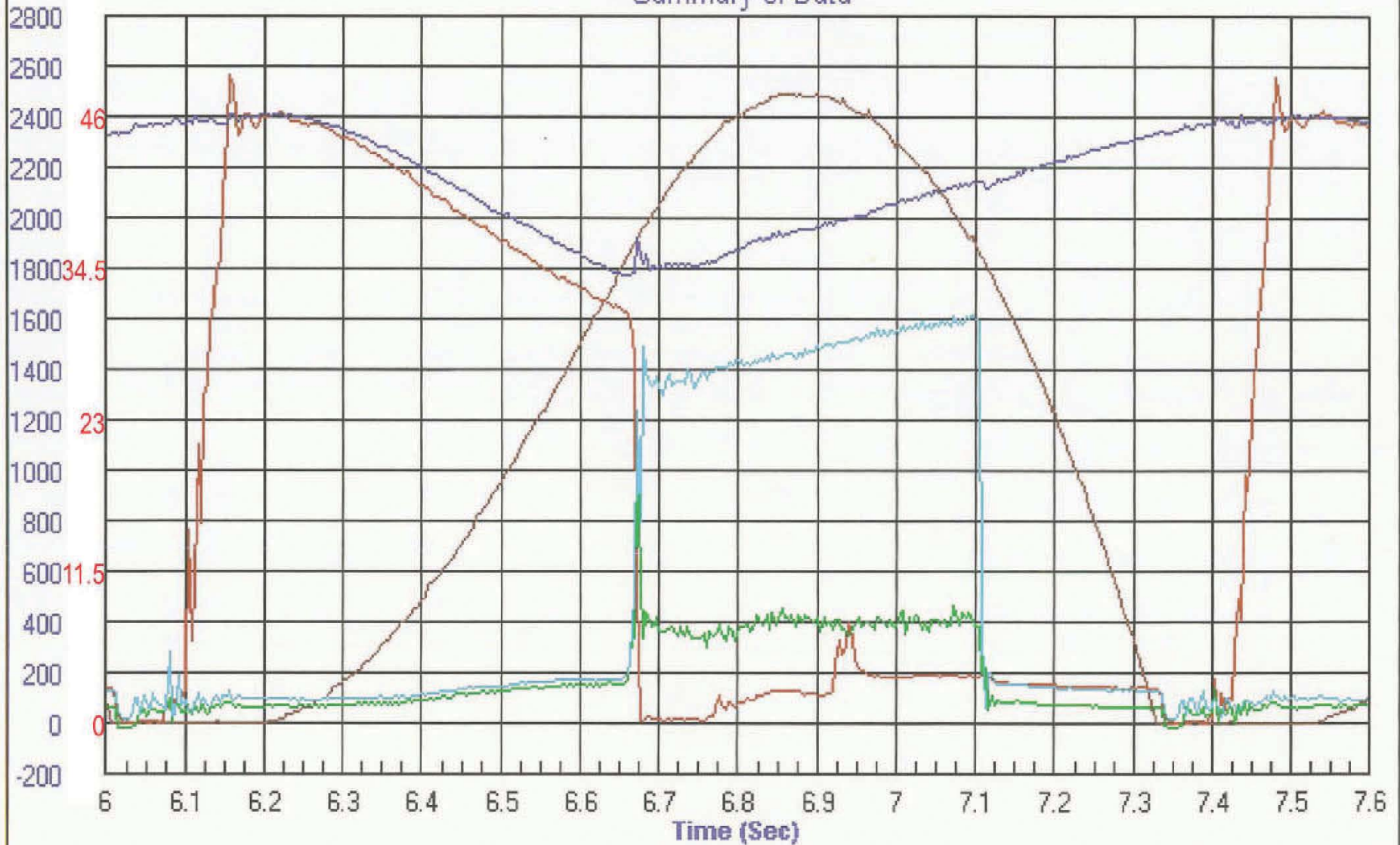

J&M MODEL 115 HIH

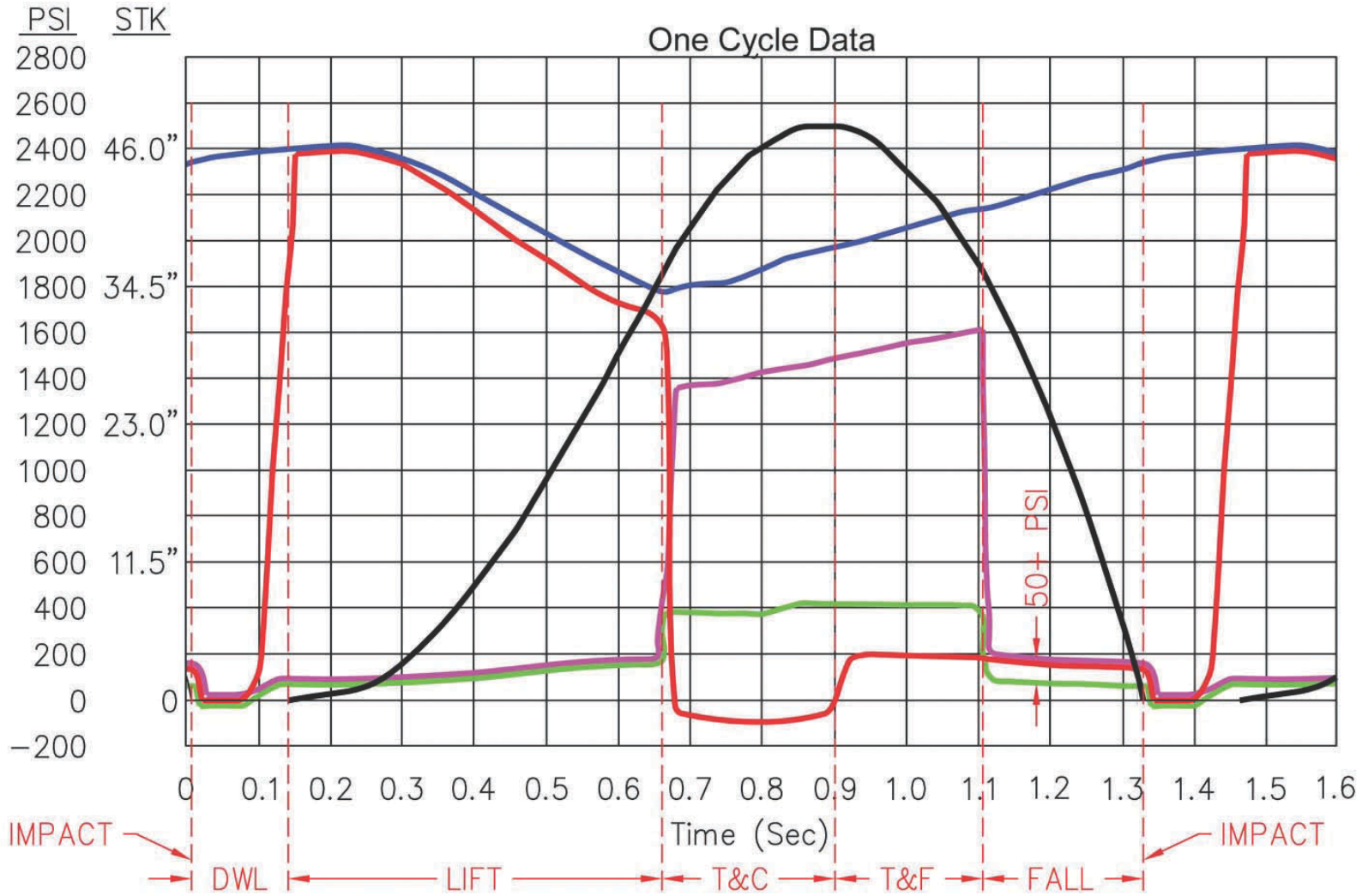

Ram Travel ——— Sys Press ——— Cyl Press ——— Return Press ——— Trip Press ———

J&M MODEL 115 HIH

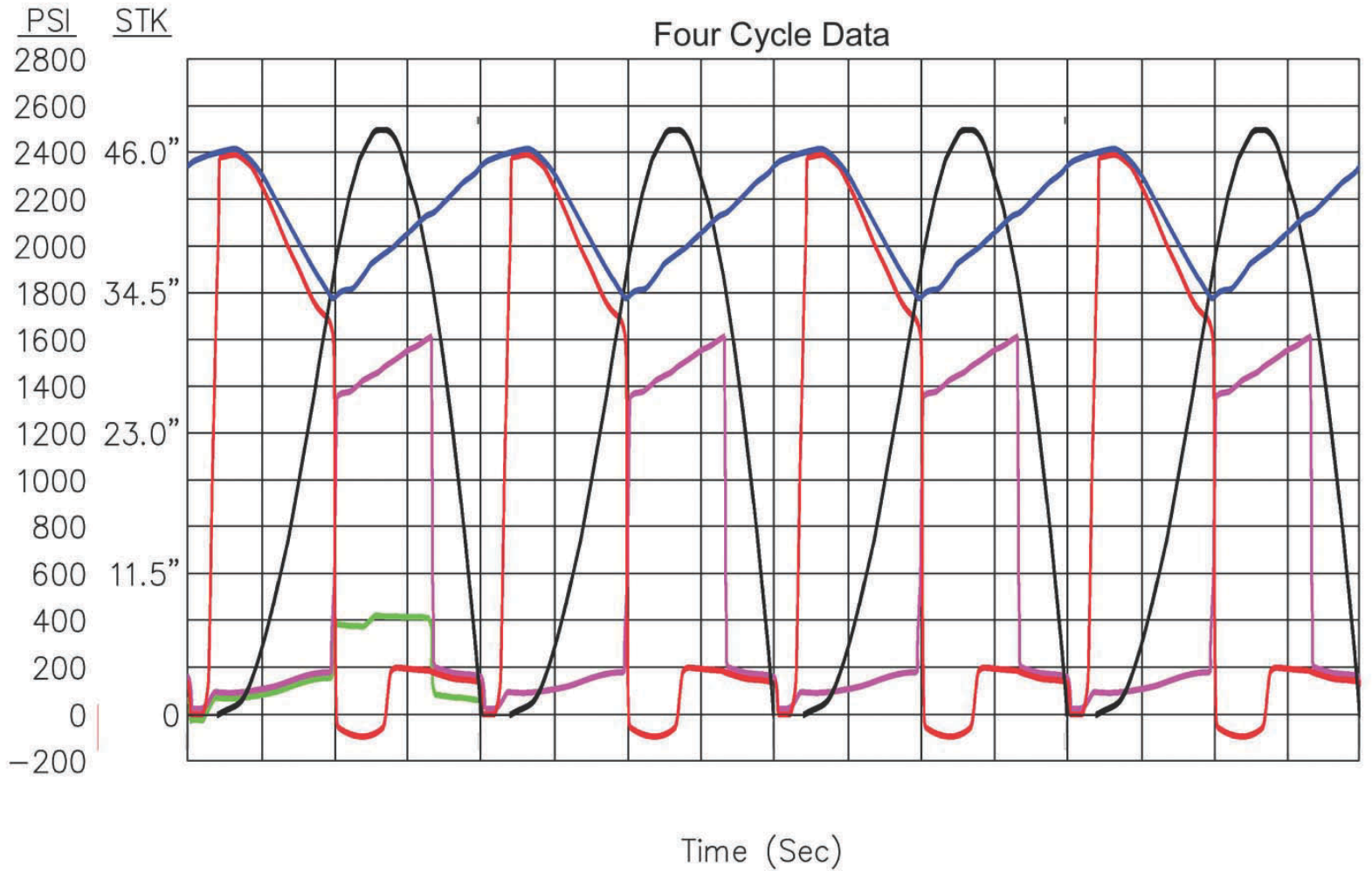

Ram Travel — Sys Press — Cyl Press — Return Press — Trip Press

SALES: *My customer needs his hydraulic hammer to go faster (BPM). Can he use a bigger power unit?*

- **BIGGER POWER UNIT WON'T HELP.**
- **SINGLE ACTING HYDRAULIC HAMMERS HAVE A SPEED LIMIT.**
- **APPROX 60% OF THE STROKE CYCLE IS UNRELATED TO HYDRAULIC POWER.**
- **ONLY THE "LIFT" PHASE IS AFFECTED BY THE POWER UNIT FLOW.**
- **EVEN "LIFT" TIME IS LIMITED BY MAXIMUM ALLOWABLE PRESSURE FOR AN HIH.**
- **HAMMER HYDRAULIC COMPONENTS NOT RATED FOR ADDITIONAL PRESSURE.**
- **VERY LARGE POWER UNIT WOULD HAVE IMPERCEPTIBLE AFFECT ON BPM.**
- **BIGGER POWER UNIT WOULD ONLY CREATE EXCESSIVE HEAT, WITH NO SPEED INCREASE.**

J&M MODEL 115 HIH

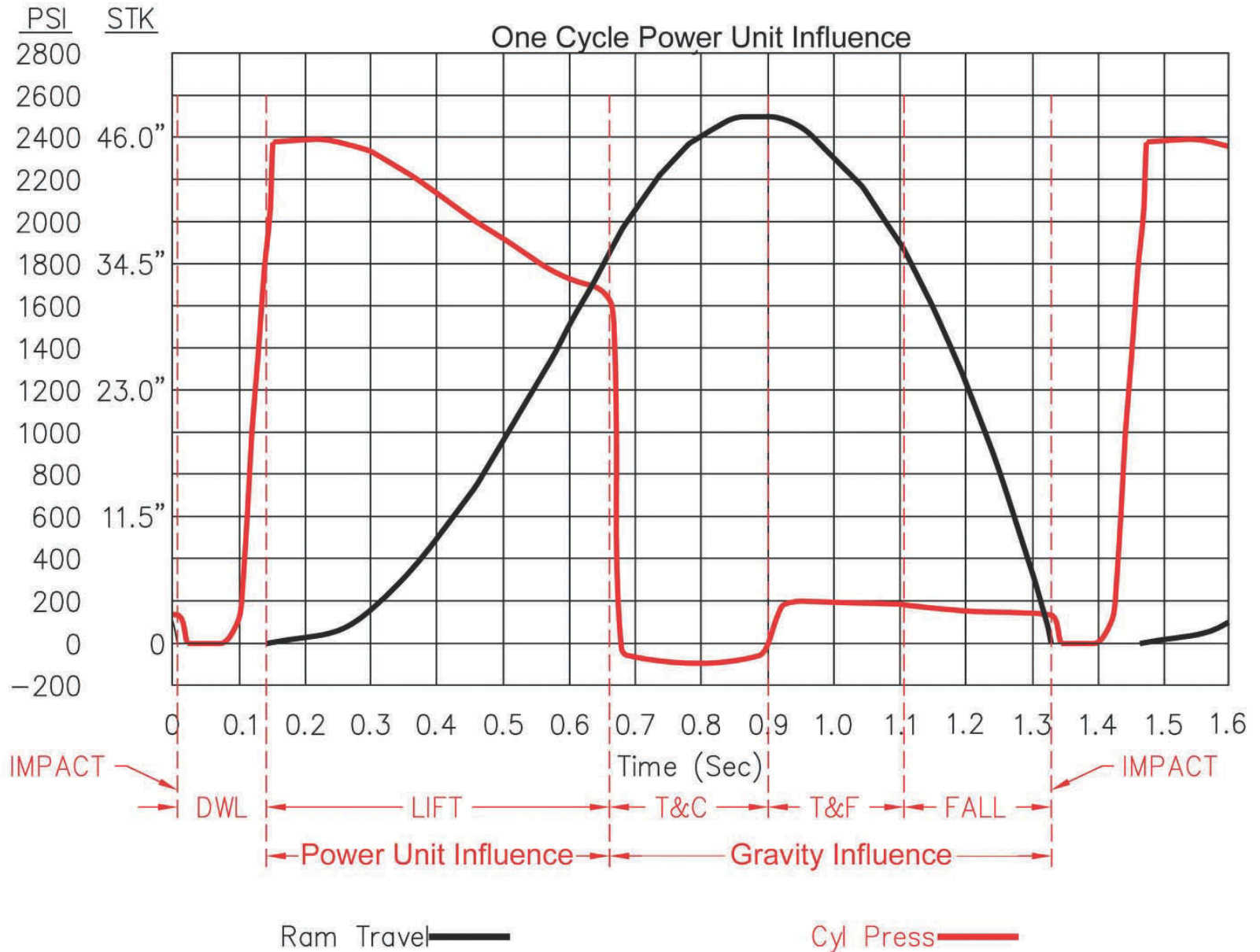

SALES: My customer's hydraulic hammer overheats. What's wrong with the hammer?

- **NOTHING IS WRONG WITH THE HAMMER.**
- **WE NEGLECTED TO TRAIN CUSTOMER ON CORRECT OPERATION OF A HIH.**
- **J&M HYDRAULIC HAMMERS ARE THE MOST EFFICIENT DEVICES THAT WE SELL.**
- **CYLINDER IS NATURALLY MORE EFFICIENT THAN MOTORS, PER VIBROS AND DRILLS.**
- **HAMMER VALVES AND PASSAGES ARE QUITE LARGE, AND NOT RESTRICTING.**
- **NO FLOW CONTROLS OR PRESSURE RELIEFS ARE IN THE HAMMER TO MAKE HEAT.**
- **HYDRAULIC HAMMERS HAVE A SPEED LIMIT SPECIFIC TO HAMMER SIZE AND STROKE.**
- **MAX POWER UNIT FLOW IS MATCHED TO HAMMER REQUIREMENTS AT FULL STROKE.**
- **ACCUMULATORS ARE FULL WHEN GAS PRESSURE EQUALS MAX SYSTEM PRESSURE.**
- **REDUCING HAMMER STROKE EFFECTIVELY CREATES A SMALLER HAMMER.**
- **SMALLER HAMMER NEEDS SMALLER POWER UNIT (SEE CHART) USES LESS FLOW.**
- **SAME POWER UNIT RPM AS FULL STROKE MAKES EXCESS FLOW AT SHORT STROKE.**
- **EXCESS FLOW GOES OVER RELIEF AND CREATES HEAT – EVERY STROKE.**
- **REDUCE RPM TO MATCH FLOW TO THE STROKE SELECTED.**
- **EVERY TIME STROKE IS CHANGED, POWER UNIT FLOW MUST BE CHANGED TO MATCH.**
- **NO EXCESS FLOW = NO EXCESS HEAT.**

J&M MODEL 115 HIH

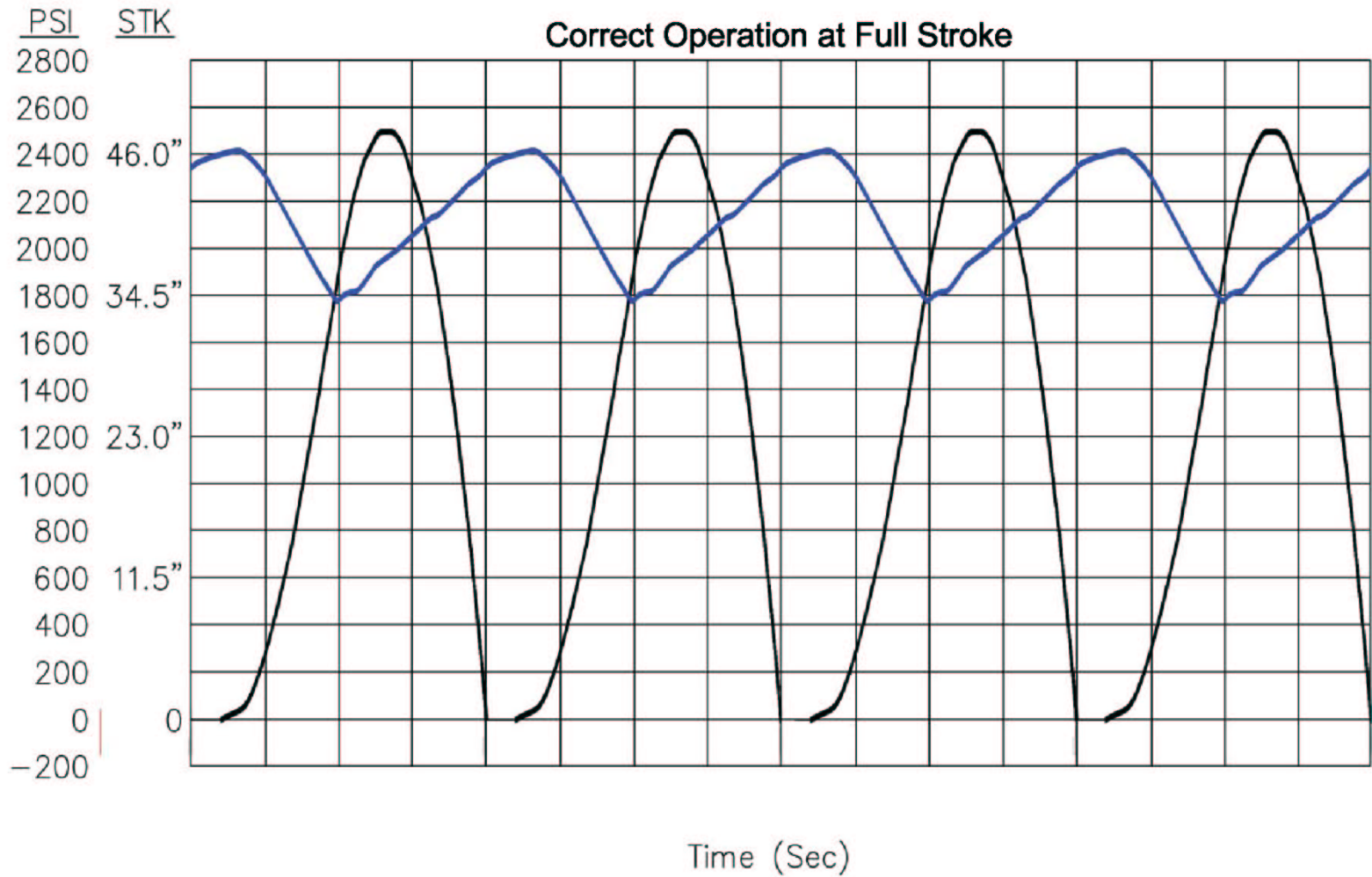

Ram Travel ——— Sys Press ———

J&M MODEL 115 HIH

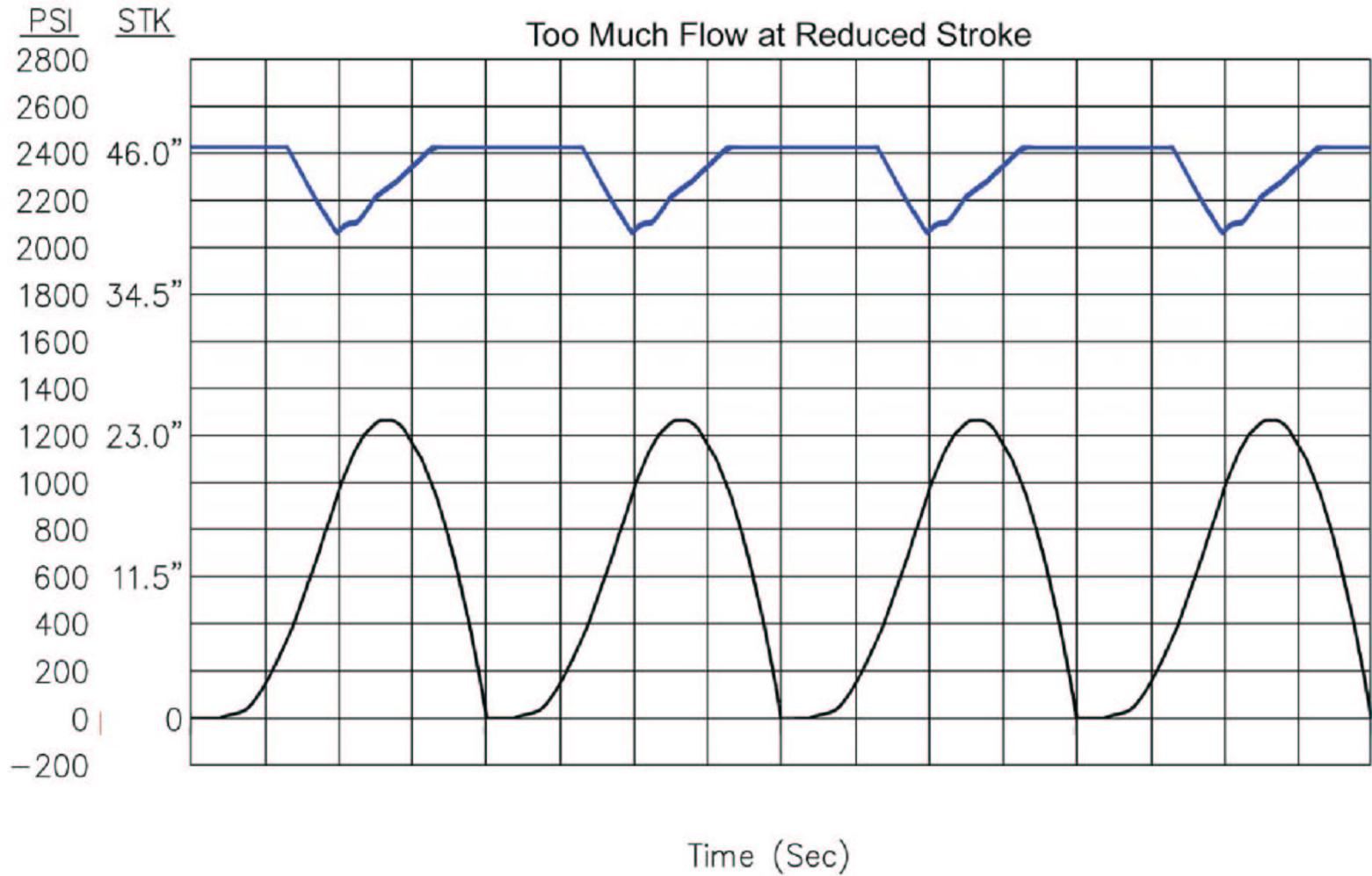

Ram Travel ——— Sys Press ———

J&M MODEL 115 HIH

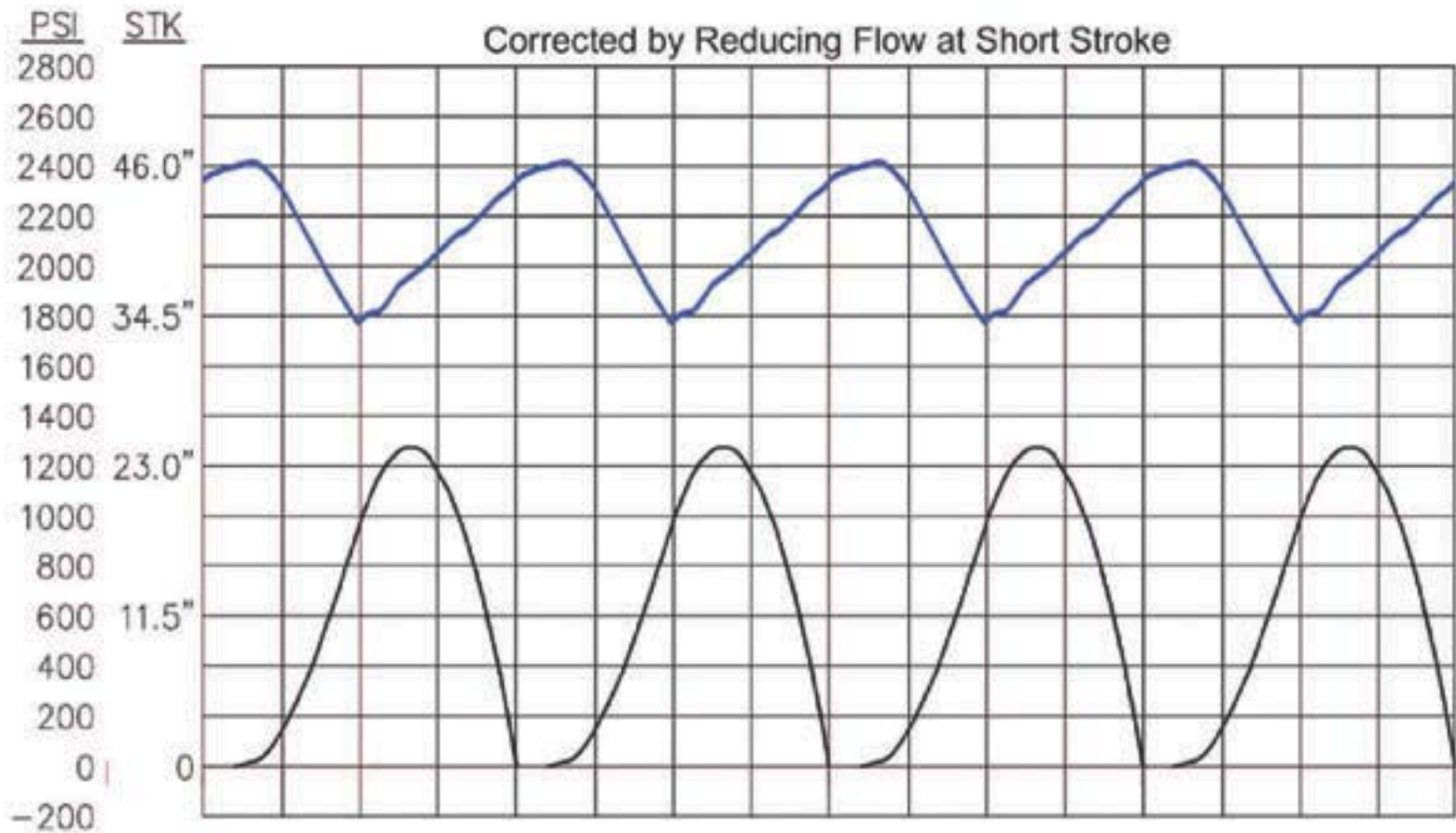

Time (Sec)

Ram Travel ——— Sys Press ———

SALES: *My customer's hammer isn't hitting hard enough (PDA). He wants bigger hoses.*

- **CONVENTIONAL LOGIC SAYS THAT RETURN FLOW RESTRICTION WILL SLOW RAM FALL.**
- **THE BEAUTY OF THE J&M HIH IS HOSE RESTRICTION HAS NO AFFECT ON FALL VELOCITY.**
- **REVIEW “TRIP + FALL” & “FALL” FLOW DIAGRAMS.**
- **FLOW EXITING CYLINDER DURING FALL PHASES GOES DIRECTLY TO BACK OF CYLINDER.**
- **FLOW PATH IS EXTREMELY LARGE AND SHORT, CREATING NO BACK PRESSURE.**
- **IN FACT, RETURN HOSE COULD BE CLOSED DURING FALL PHASES WITHOUT EFFECT.**
- **NO OTHER HYDRAULIC COMPONENTS IN J&M HIH RESTRICT FALL PHASES.**
- **LOW PDA EFFICIENCIES ARE ALMOST ALWAYS DUE TO;**
 - **DAMAGED DRIVE CAP AND/OR INSERT.**
 - **PROBLEMS WITH HAMMER OR PILE CUSHION MATERIAL**
 - **EXCESS FRICTION IN HAMMER COLUMNS OR RAM BEARINGS.**

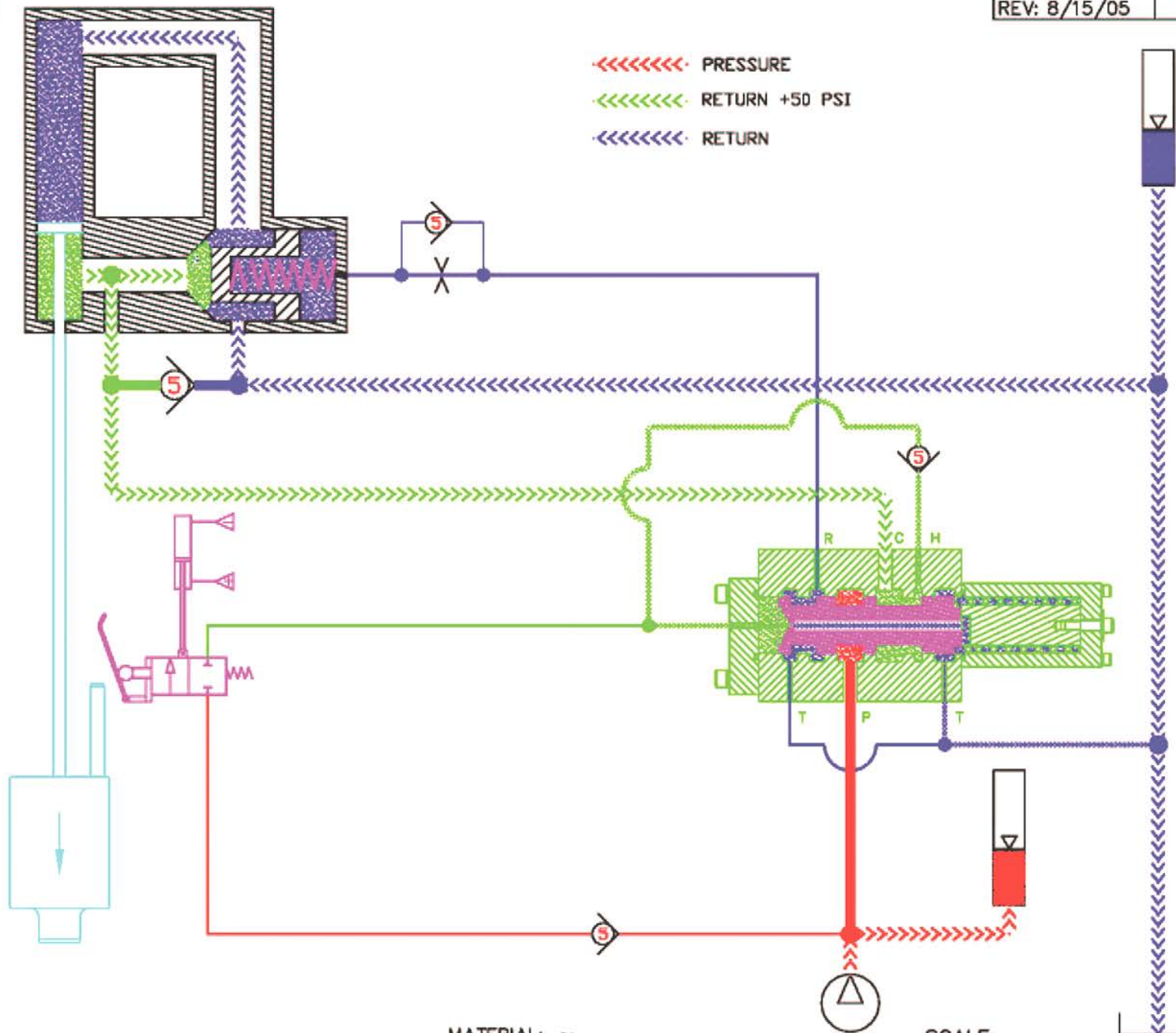

MATERIAL: ~

SCALE: ~



SALES: *The ram is hesitating during the LIFT cycle – near top of stroke.*

- THE “LIFT” FLOW DIAGRAM SHOWS FLOW TO CYLINDER IS FROM BOTH THE PRESSURE ACCUMULATOR, AND THE POWER UNIT.
- IF ACCUMULATOR IS TOO SMALL, OR UNDER FILLED, THE ACCUMULATOR PISTON WILL BOTTOM OUT (FLOW STOPS) BEFORE THE RAM REACHES THE TRIP POINT.
- WHEN ACCUMULATOR FLOW STOPS, THE HIH RAM MUST STOP, OR EVEN FALL BACK, UNTIL IT'S SPEED CAN MATCH THAT OF POWER UNIT FLOW ONLY.
- WE USE PISTON ACCUMULATORS IN ALL J&M HYDRAULIC HAMMERS.
- PISTON ACCUMULATORS INHERENTLY HAVE MINOR LEAKAGE OF OIL INTO GAS VOLUME, ESPECIALLY AT HIGH SPEED, DUE TO SEAL HYDROPLANE.
- OIL IN THE GAS END EFFECTIVELY MAKES THE ACCUMULATOR SMALLER.
- TO CORRECT PROBLEM, DRAIN OIL FROM GAS END BY SLIGHTLY OPENING THE GAS VALVE (Schroeder), WITH GAS END DOWN.
- CHECK GAS PRESSURE AFTER DRAIN, AND RECHARGE AS REQUIRED.
- HIH MAINTENANCE SHOULD INCLUDE ACCUMULATOR DRAIN ON A WEEKLY BASIS.
- ALSO, TOO LITTLE FLOW FROM POWER UNIT, FOR A GIVEN STROKE, MAY CAUSE SIMILAR HESITATION. INCREASE FLOW TO CORRECT.
- INCREASING FLOW WILL NOT CORRECT HESITATION CAUSED BY OIL IN THE GAS END, BUT WILL INCREASE HEAT GENERATION.

SALES: "Redneck Construction" wants to rebuild their accumulators. Please send them seal kits.

- **BAD IDEA! ACCUMULATORS ARE POTENTIALLY THE MOST DANGEROUS ITEMS WE USE.**
- **GAS PRESSURE IN OUR ACCUMULATORS REGULARLY EXCEEDS THAT IN TYPICAL CUTTING TORCH OXYGEN BOTTLES.**
- **ALL PARTS OF ACCUMULATORS ARE POTENTIAL PROJECTILES IF DISASSEMBLED WITHOUT REMOVING PRESSURIZED GAS. AN EASY MISTAKE TO MAKE BY UNTRAINED PERSONNEL.**
- **ACCUMULATOR MANUFACTURERS ATTEMPT TO MAKE CERTAIN SAFETY FEATURES, BUT THEY ARE EASILY DEFEATED.**
- **CONTRACTORS MAY DRAIN OIL, AND RECHARGE GAS, BUT ENCOURAGE THEM TO SEND ACCUMULATORS TO A QUALIFIED COMPANY FOR REBUILD OR INSPECTION.**
- **NEVER WELD ON AN ACCUMULATOR.**
- **NEVER HEAT ACCUMULATORS TO FACILITATE FITTING REMOVAL.**
- **NEVER REMOVE, OR PAINT OVER, ACCUMULATOR WARNING LABELS.**
- **DO NOT ALLOW CONTINUED USE OF HYDRAULIC HAMMERS IF ACCUMULATOR BECOMES LOOSE IN ITS MOUNTING CLAMPS.**
- **ALL ACCUMULATORS ARE DESIGNED AND MANUFACTURED BY OTHERS, SO LIABILITY SHOULD BE ASSUMED BY THEM IF DEFECTIVE.**
- **HOWEVER, LIABILITY COULD BE SHARED BY US IN CASE OF INSUFFICIENT WARNING.**

ACCUMULATOR

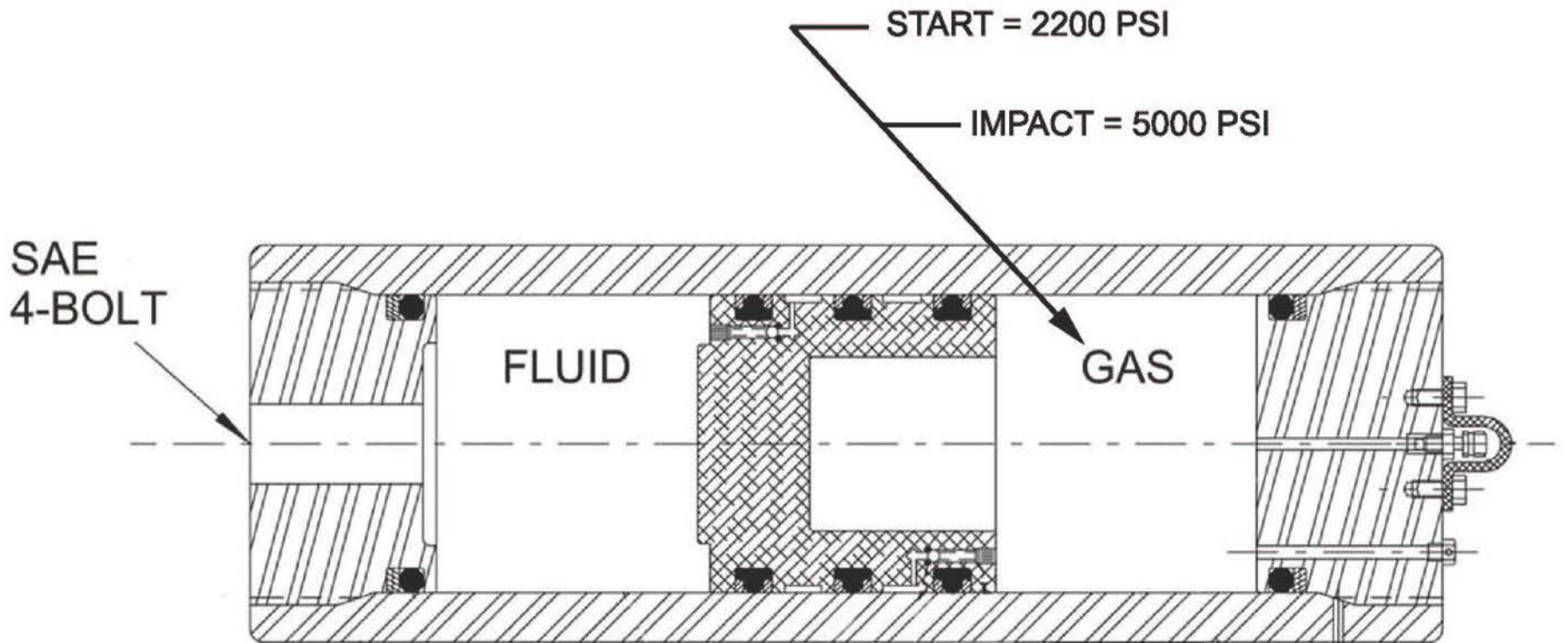

ENERGY MONITORING & RECORDING

e-Saximeter



